



VATEK

ENVIRONMENTAL TECHNOLOGIES

**WE TREAT
THE
WORLD'S
WATER! ®**

***WATER, WASTE WATER TREATMENT AND
RECYCLING SYSTEMS***





- To be a sole solution partner for our customers on all water-related issues; we provide comprehensive solutions, including **turnkey contracting, consultancy, after sales services and consumables and equipments supply.**
- **Vatek Family**, expanding both locally and globally, is dedicated showcasing the strength of its **engineering and craftsmanship** to the entire world. We do this through our partner companies in **Albania, UAE**, and our sales office in the **UK**.

○ ○ ○ ○ **SERVING MORE THAN 65 COUNTRIES**



***Global Network and
Worldwide
References***

**Both Water and
Wastewater Systems
Expertise**

OUR STRENGTH

**Tailor-made Solutions for
Our Customers**

***The Engineering
Department's Ability to
Provide Quick Responses
to Customer Requests***

**Integrated Tools like
Demonstrations,
Lectures, Speeches,
Reports etc**

***Supervision and
technical expertise
on the field***

WHAT WE DO ?

WATER TREATMENT SYSTEM

- Pre-Filtration Systems
- Ultrafiltration Systems
- Reverse Osmosis Systems
- Sea Water Treatment Systems
- River Water Treatment Systems
- Greywater and Rainwater Treatment Systems
- Container Type Water Treatment Systems
- Trailer - Type Water Treatment Systems
- Greenhouse Water Treatment Systems

WASTEWATER TREATMENT SYSTEM AND RECYCLING SYSTEM

- Conventional Type Wastewater Treatment Systems
- Chemical Package Type Wastewater Treatment Systems
- SBR (Sequential Batch Bioreactor) Systems
- MBBR (Moving Bed Bioreactor) Systems
- MBR (Membrane Bioreactor) Systems
- Package Type Textile Wastewater Treatment and Recycling Systems



PLC

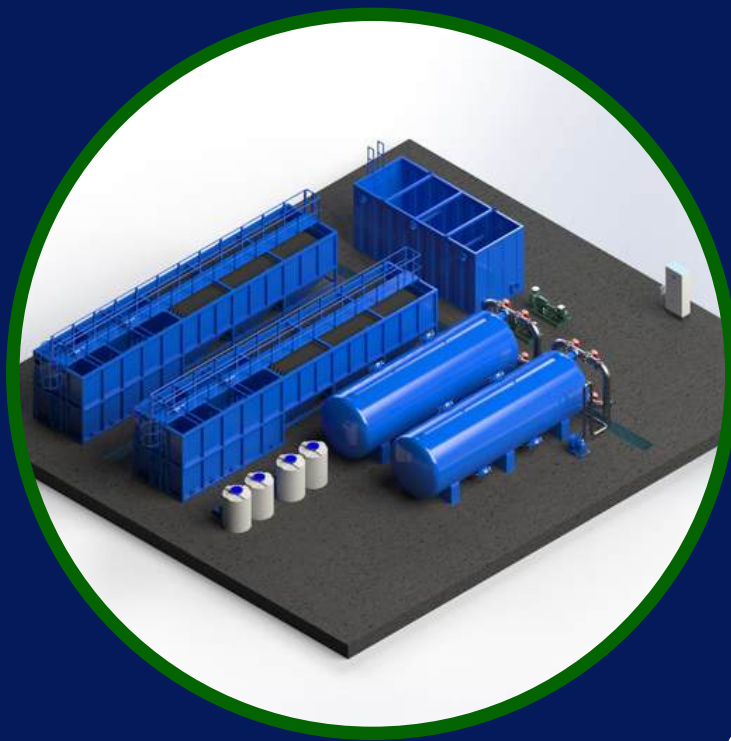

3D Drawings

Manufacturing

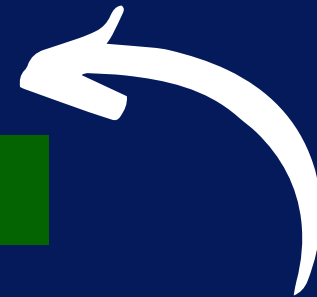

WHAT IS IN OUR SCOPE ?

Welding

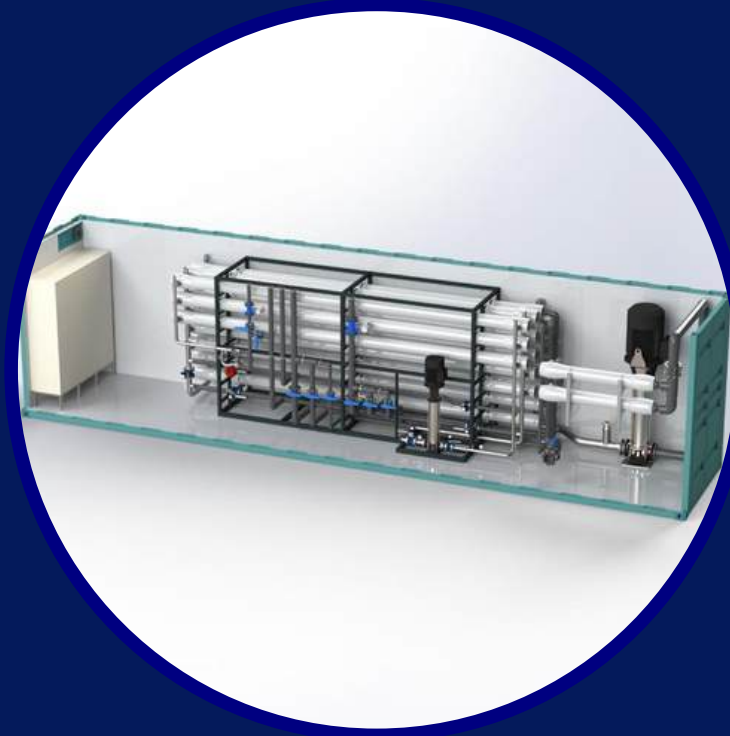

Automation

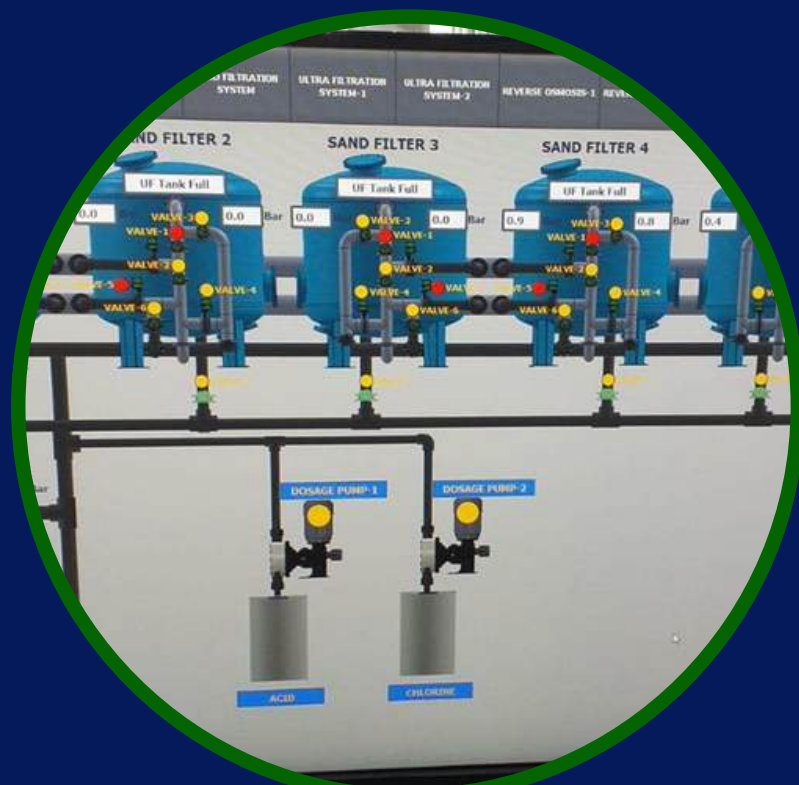



FILTRATION SYSTEMS

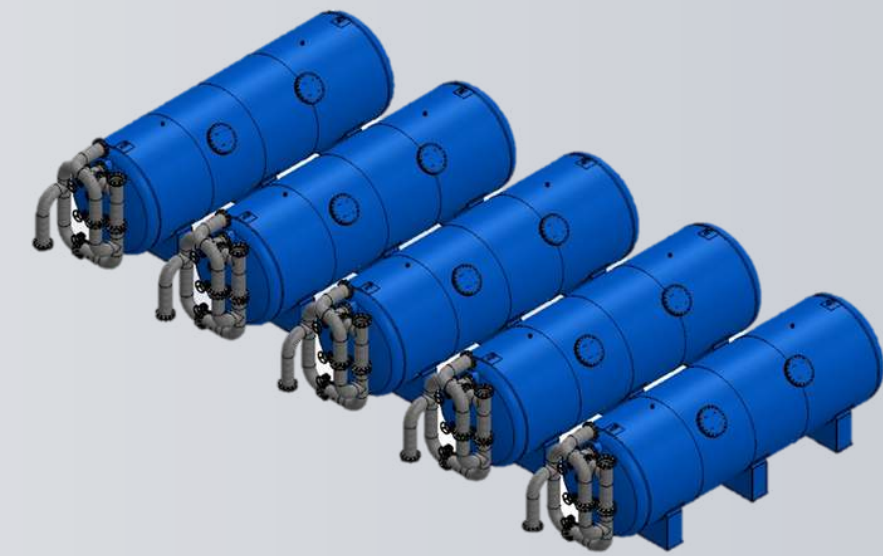

We design and manufacture for treatment of physical pollutants and chemical removal from water sources.

The body material can be manufactured according to user needs as stainless steel or carbon steel. The systems are fully automatic and PLC controlled.

The body shape can be manufactured vertical or horizontal.

- Tailor Made Solutions
- Unlimited Capacity
- Easy Assembly
- Easy Monitoring
- Long Lifetime
- High Efficiency



Bangladesh



Azerbaijan



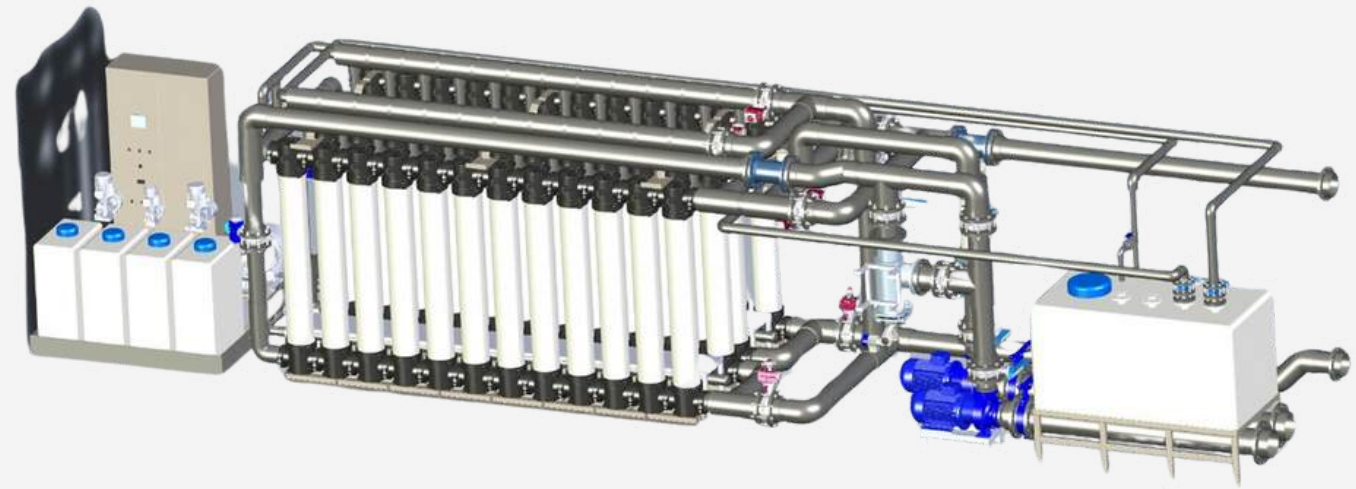

ULTRAFILTRATION SYSTEMS



Ultrafiltration is a membrane separation process in which a porous membrane is used to separate or reject colloidal and **suspended solids** also with **removing of bacteria and viruses** with 0,02 micron filtration rate.

- The most reliable system for drinking water production.
- Treatment efficiency is more than 95%
- Fully automatic and PLC controlled
- Easy to operate
- No need more space



ULTRAFILTRATION SYSTEMS



Application Areas

- Natural Spring Water Bottling
- Facilities Beverage Industry
- Food Industry
- Re-use of waste water prefilters for the RO systems
- Pharmaceutical Industry
- Electronic Industry
- Chemical Industry
- Agriculture and Livestock
- Aviation and Maritime
- Automotive Industry
- Energy Industry
- Hotels and Holiday Villages
- Construction Industry
- Textile Industry
- Defense and Military Industry
- Hospitals and Health Institutions



REVERSE OSMOSIS SYSTEMS

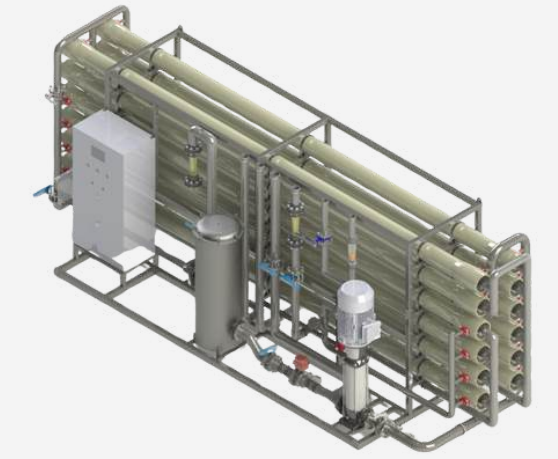

- Dissolved organic and inorganic substances (bitter, high conductivity, etc) salts, heavy metals, viruses and bacteria in the water are treated with reverse osmosis systems Up to 96 - 99 % of purity in water could be achieved.
- Water with different sources such as well water, tap water, sea water etc could be treated with high purity using Reverse Osmosis Systems.



REVERSE OSMOSIS SYSTEMS

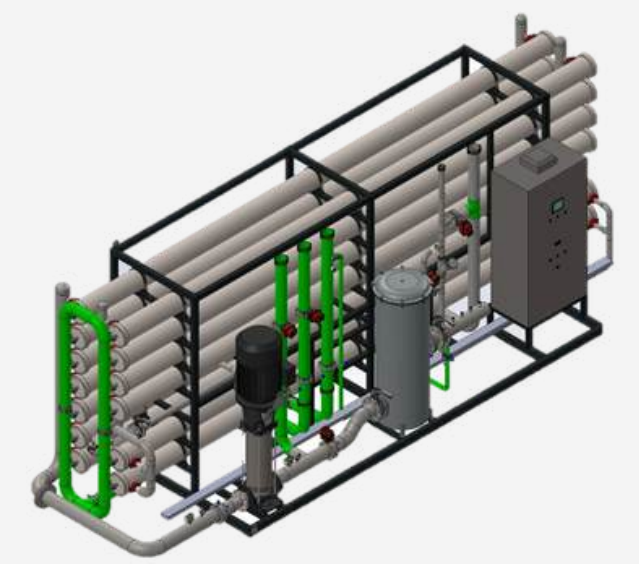

- RO Systems can be produced according to user needs such as single pass, double pass, heat sanitizable system.
- All our systems are tailor made
- System piping materials, control systems, automation, energy recovery, all system instruments are chosen depends on the project
- Remote control can be added

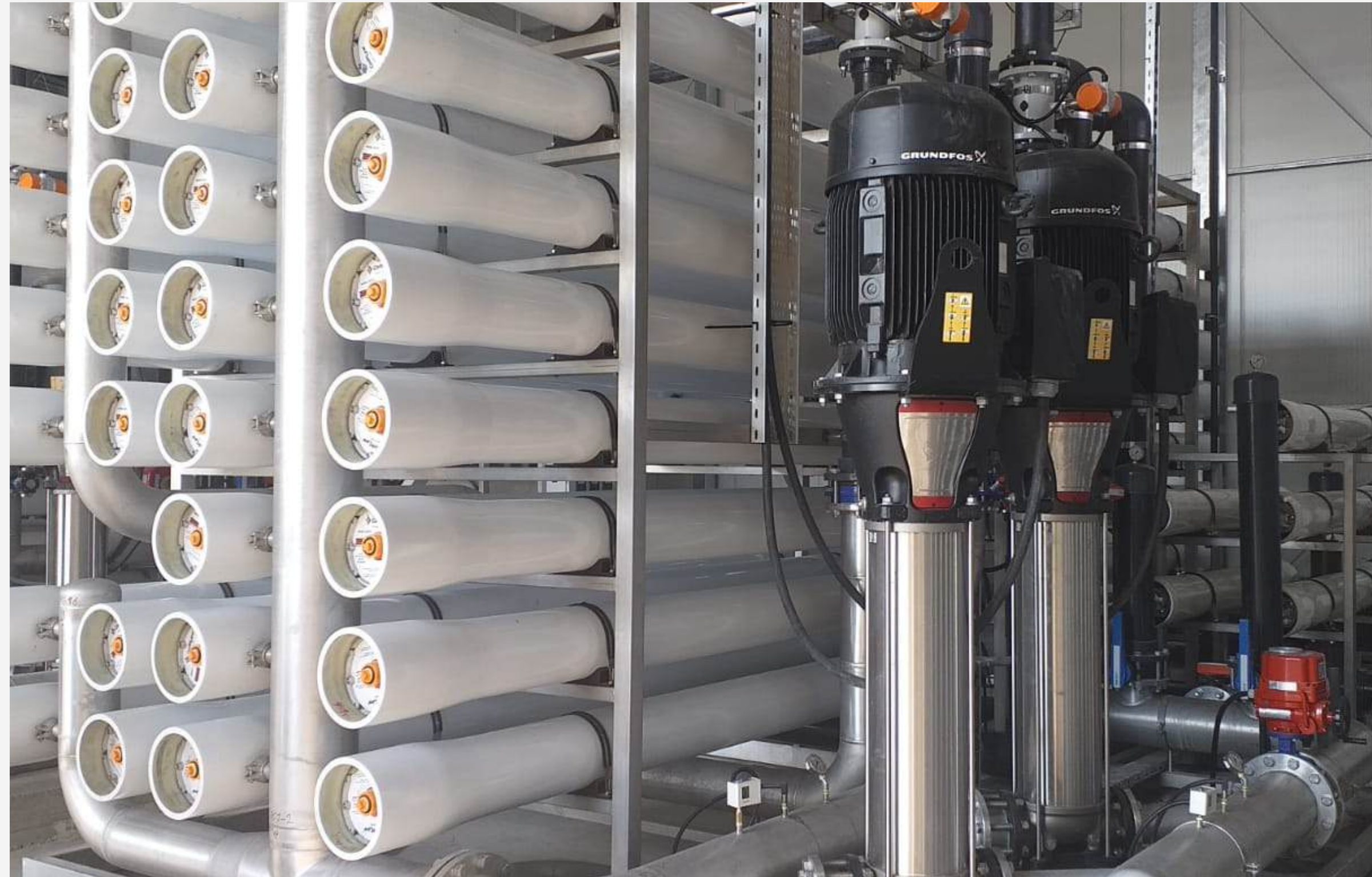

REVERSE OSMOSIS SYSTEMS

Application Areas

- Natural Spring Water Bottling
- Facilities Beverage Industry
- Food Industry
- Pharmaceutical Industry
- Electronic Industry
- Chemical Industry
- Agriculture and Livestock
- Aviation and Maritime
- Automotive Industry
- Energy Industry
- Hotels and Holiday Villages
- Construction Industry
- Textile Industry
- Defense and Military Industry
- Hospitals and Health Institutions



SEA WATER TREATMENT SYSTEMS

- Reverse Osmosis system is one of the most common methods for the desalination of sea water.
- The salinity of water is removed by sea water treatment systems and the water is converted to freshwater quality.
- Seawater treatment systems provide water for **general use** or **potable water**.
- 95%-99% salt removal is achieved
- Tailor made solutions

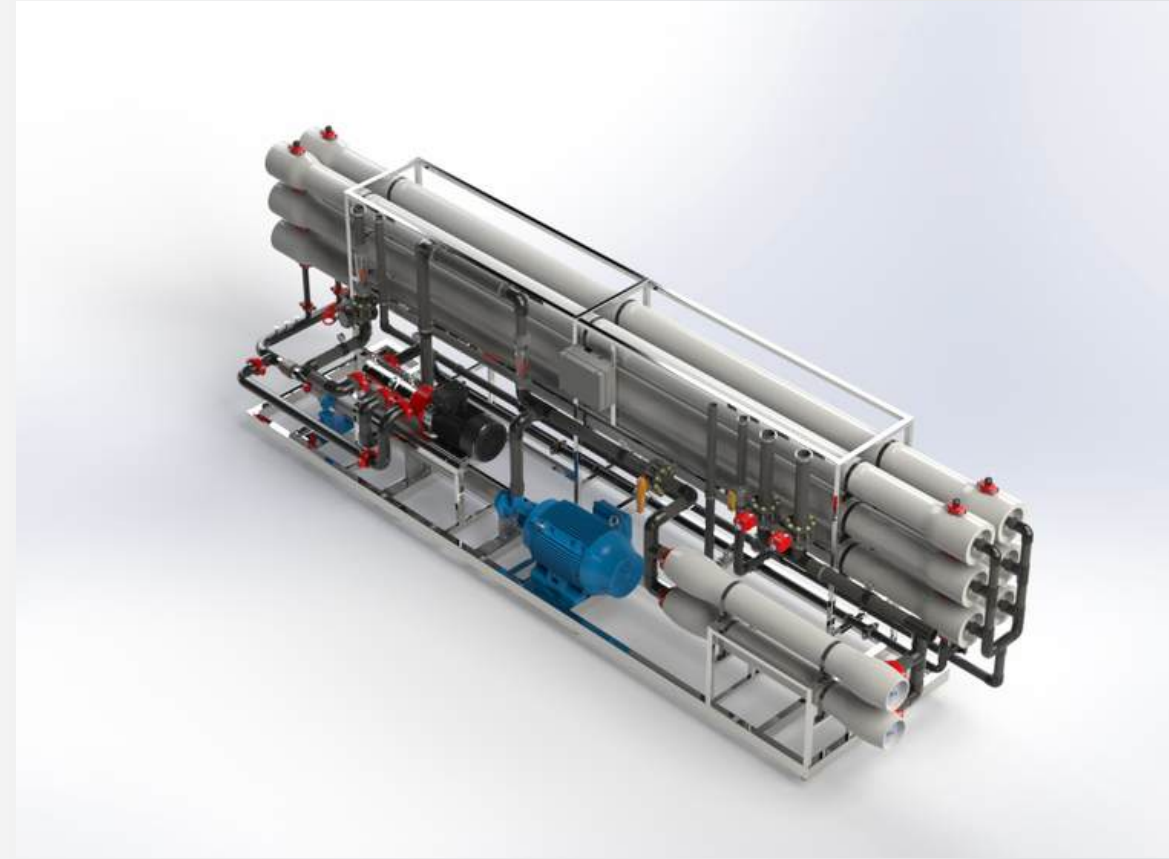

Somalia

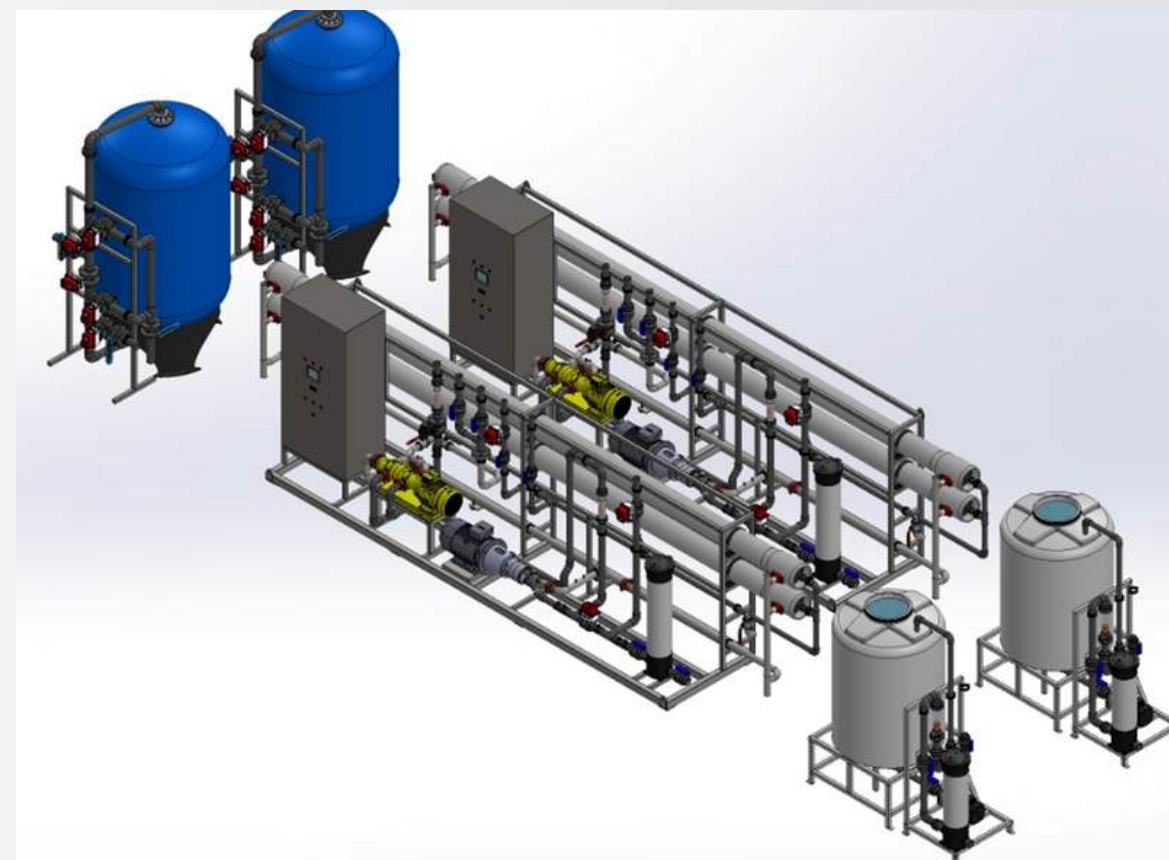

Tanzania



RIVER WATER TREATMENT SYSTEMS

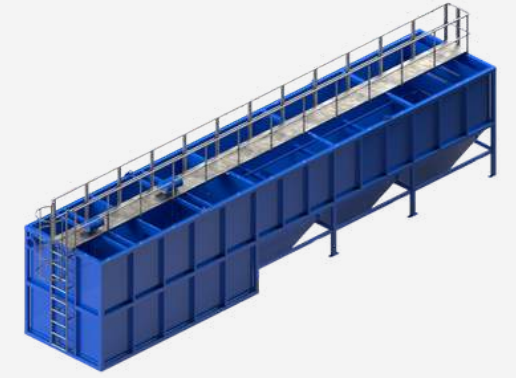

River water contains too much particles. The high amount of particles are removed from the water by river water treatment systems.

River water treatment systems are designed specially for drinking or domestic Water according to user demands.

We have done lots of UNDP projects as now on.

Systems are used in:

- The villages and rural areas
- Current temporary areas
- Industrial zones
- Industrial facilities
- Construction fields
- Military regions
- Refugee camps
- Construction site and field



CONTAINER TYPE WATER TREATMENT SYSTEM



Our the most populer product !

- Container systems can be designed tailor-made, regardless of the raw water supply and the amount of water to be treated.
- It meets the need of water in a quick and reliable way.
- It doesn't require so much space and no need for additional buildings
- In case of any increase in the capacity it can easily increased by increasing the number of containers in a parallel way.
- 20 feet - 40 feet air-conditioned and insulated containers as it is suitable for all climatic conditions
- Container type water treatment systems are fully assembled inside the container and ready for commissioning.



Egypt

Democratic Republic of Congo

CONTAINER TYPE WATER TREATMENT SYSTEM

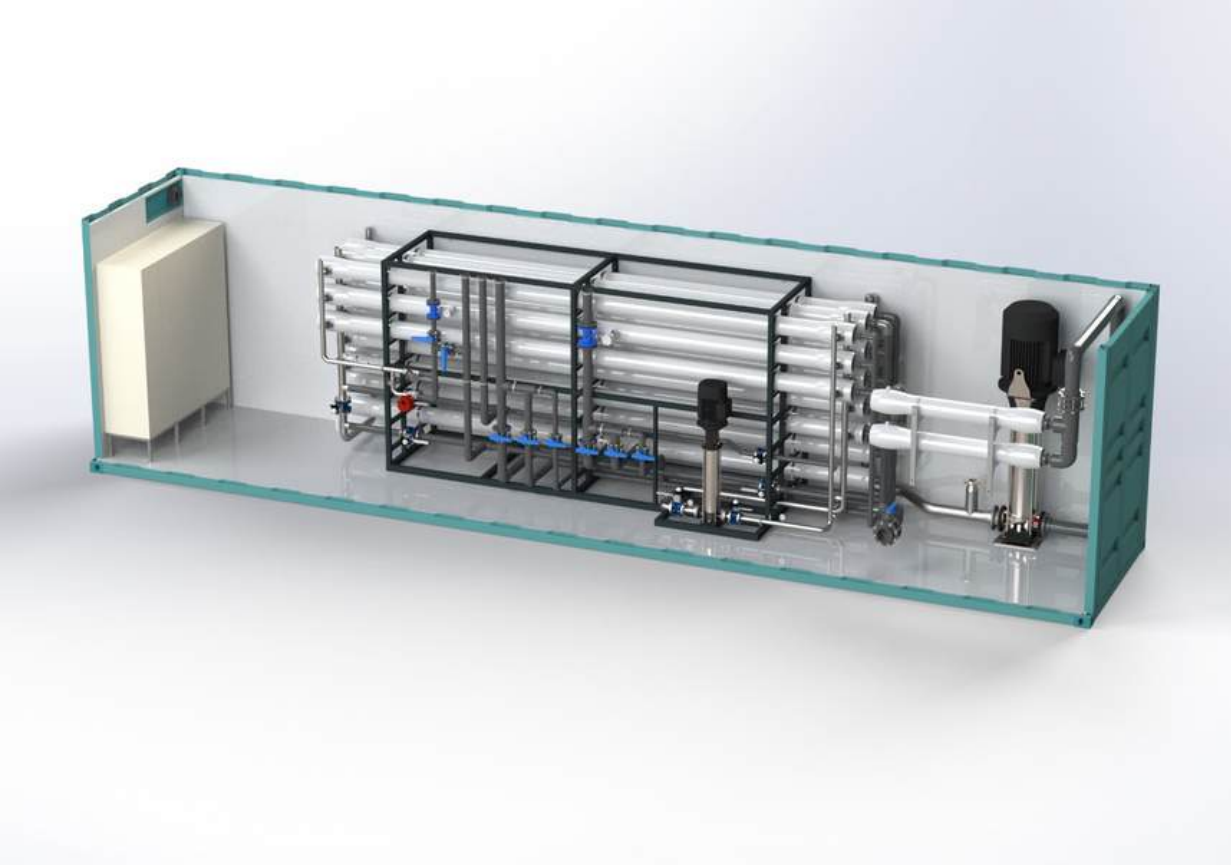

TRAILER TYPE WATER TREATMENT SYSTEMS

- Trailer type water treatment systems are designed tailor-made, regardless of the raw water supply . The source of raw Water can be river, underground, lake, surface Water etc...
- Specially, armies need Trailer Type Water Treatment System, because this Type Water Treatment is **mobile and it has wheels**.
- Therefore it can be moved, where it is needed.
- Water Treatment System stages and equipments can change according to quality of raw Water and estimated treated Water quality.



MILITARY TYPE WATER TREATMENT SYSTEMS

Mobile water treatment systems play a crucial role in providing drinking water for military units, bearing significant importance for their operations. Thanks to their quick deployment and installation capabilities, they can be rapidly activated in emergency situations.

These systems offer operational independence, allowing units to move freely without being tied to any specific water source.

By providing reliable and safe drinking water, they eliminate contamination from local water sources in the field.

From a logistical standpoint, they are easier to transport and set up, ensuring that mobile water treatment systems are essential for securing the drinking water supply for military forces.



GREENHOUSE WATER TREATMENT SYSTEMS

Hydroponic farming relies heavily on water!

Low-quality water can lead to slow crop growth and, in some cases, gradual plant death.

With hydroponic greenhouse water treatment systems:

- Yield increases by 70%.
- Controlled growth is ensured.
- Risks of microbes, bacteria, and parasites are eliminated.
- Water conservation is achieved.
- Stacked systems result in increased product quantity.
- Produce is flavorful and healthy.
- Minimal need for pesticides and fertilizers



CONVENTIONAL TYPE WASTEWATER TREATMENT SYSTEM

These systems are specifically designed for municipalities and high-capacity industrial applications.

With conventional type waste Water treatment system, firstly, oil and large particles are removed from the water. Then, the organic pollutants are eliminated from the water through microorganisms. Subsequently, resting and disinfection processes are applied. Desired wastewater outlet values are provided with additional units according to the user's needs.

"The most prevalent applications encompass":

- The Textile Industry
- The Leather Processing Sector
- Various Manufacturing Facilities
- Rural Communities
- The Mining Sector

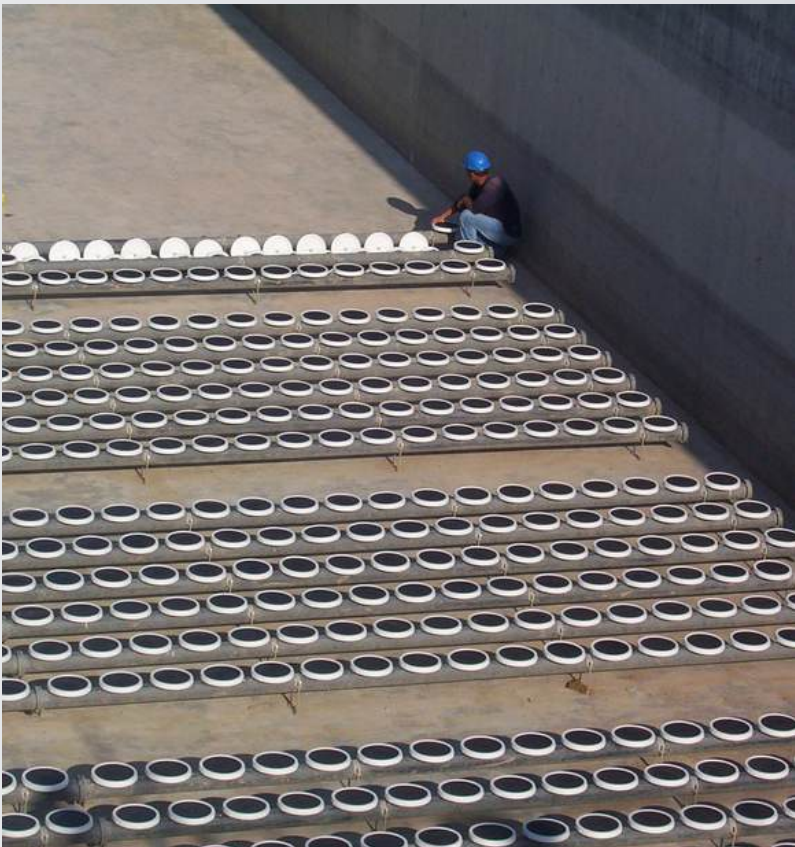

CHEMICAL PACKAGE TYPE WASTEWATER TREATMENT SYSTEM



- Small-scale WWTP units hold significant importance in regions with low population density, particularly where the economic feasibility of channeling sewage to a central WWTP via a drainage system is unviable.
- Building extensive drainage conduits is impractical for two main reasons: exorbitant expenses and the risk of wastewater stagnation.
- According to the Council Directive 91/271/EEC regarding urban wastewater treatment, in cases where the establishment of wastewater collection systems lacks economic or environmental justification, individual systems are recommended.



PACKAGE TYPE SBR (SEQUENTIAL BATCH BIOREACTOR) SYSTEMS

- The process involves treating both domestic and industrial wastewater using a sequential batch biological reactor. The operational cycle of these systems includes four key stages:
 1. Filling
 2. Aeration
 3. Settling
 4. Decanting
- This method stands out for its simplicity and costeffectiveness, making it an ideal choice for wastewater treatment. With the capability to handle capacities of up to 200m³/day using just a single package, it offers a streamlined solution.
- Furthermore, Based on the user's needs, a recycling units can be added to the system, and the desired discharge value can be achieved with a single package.

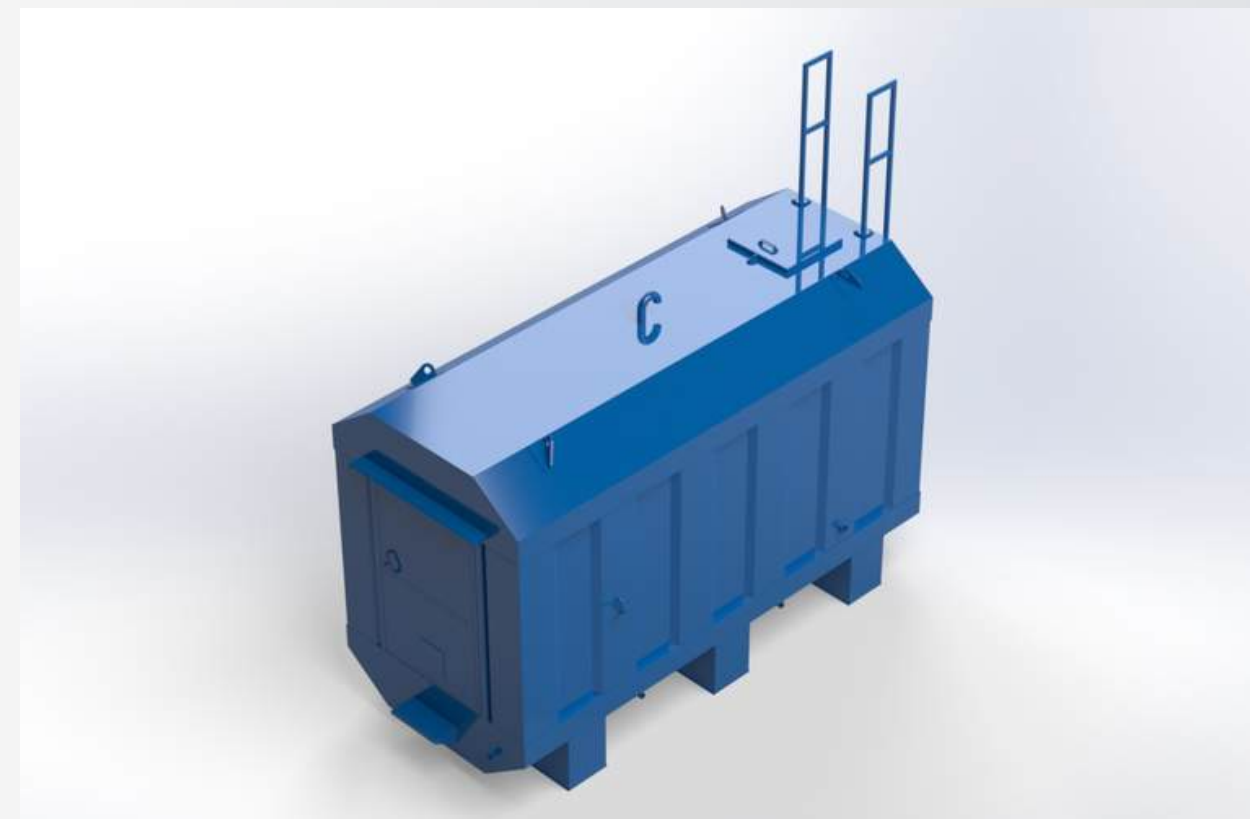
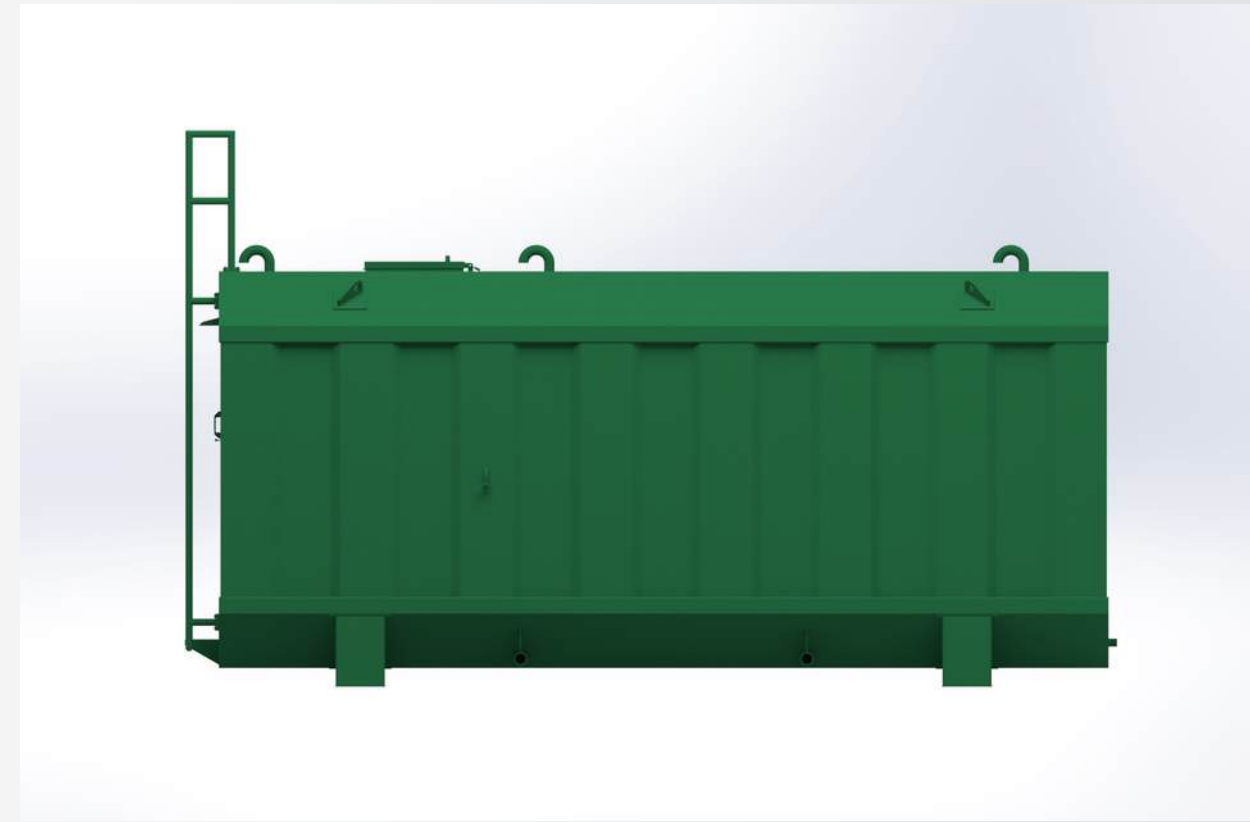

PACKAGE TYPE MBBR (MOVING BED BIOREACTOR) SYSTEMS

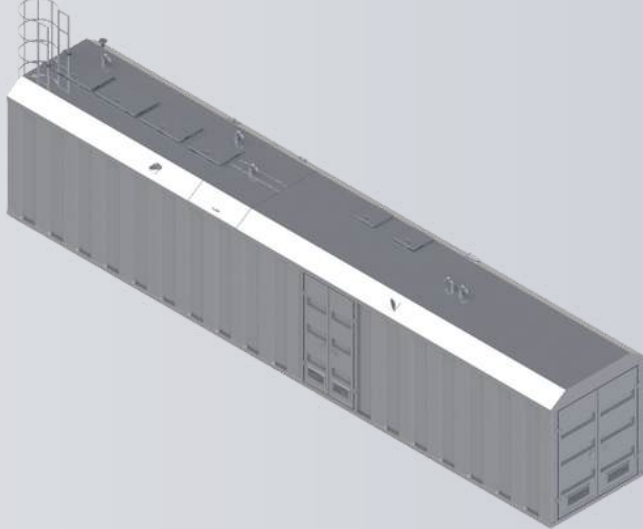

- This technology facilitates the elimination of organic pollutants found in industrial and domestic wastewaters through biofilms formed on bio media.
- It is a preferred method for wastewater treatment due to its ability to provide high efficiency in small spaces.
- The water quality output from the MBBR (Moving Bed Biofilm Reactor) system meets the ideal standards for garden irrigation.
- The system can be customized with a recovery chamber to meet the user's needs, achieving the desired discharge quality in a single package.
- It is characterized by low operational costs.
- Its effectiveness in treating highly polluted wastewaters makes it a favored choice.



Jordan



Jordan



PACKAGE TYPE MBR (MEMBRANE BIOREACTOR) SYSTEMS

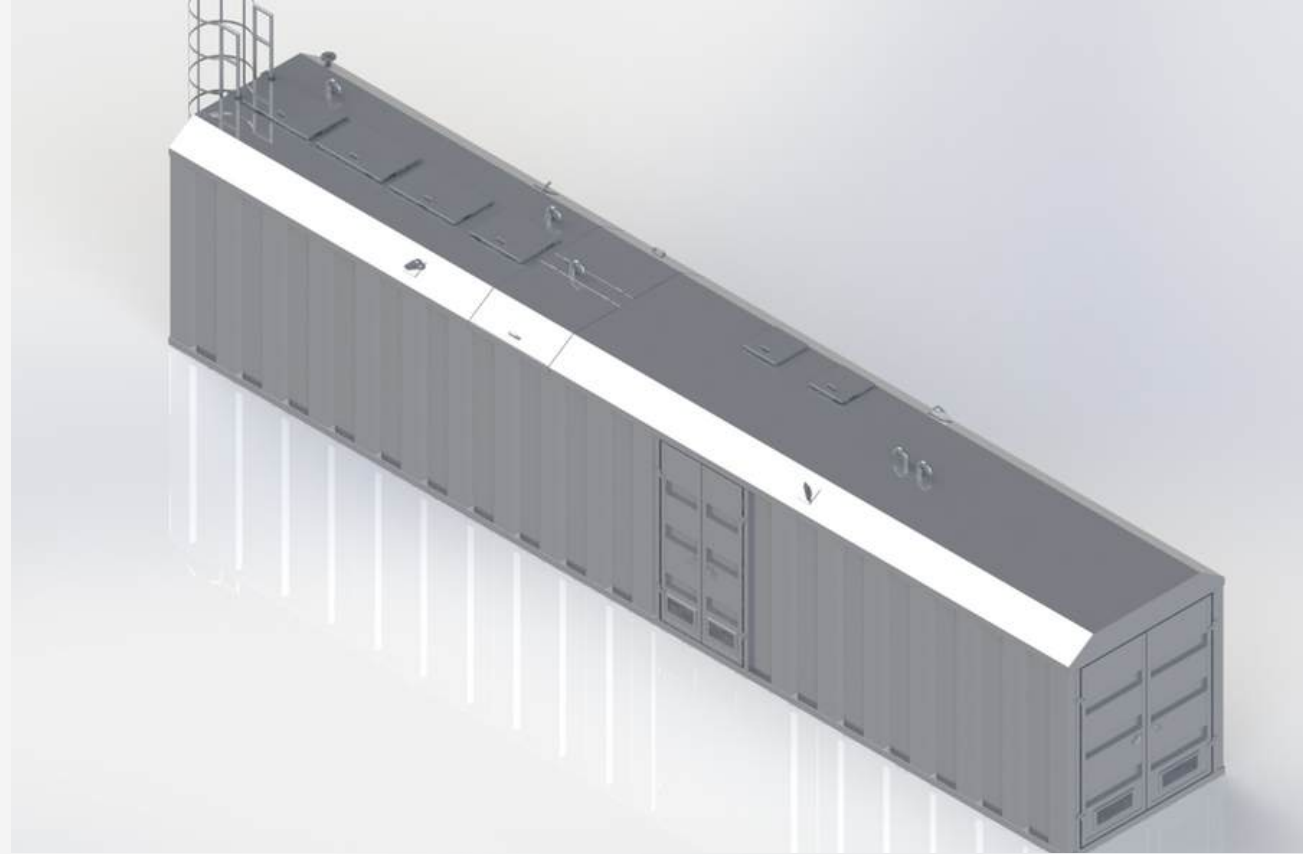
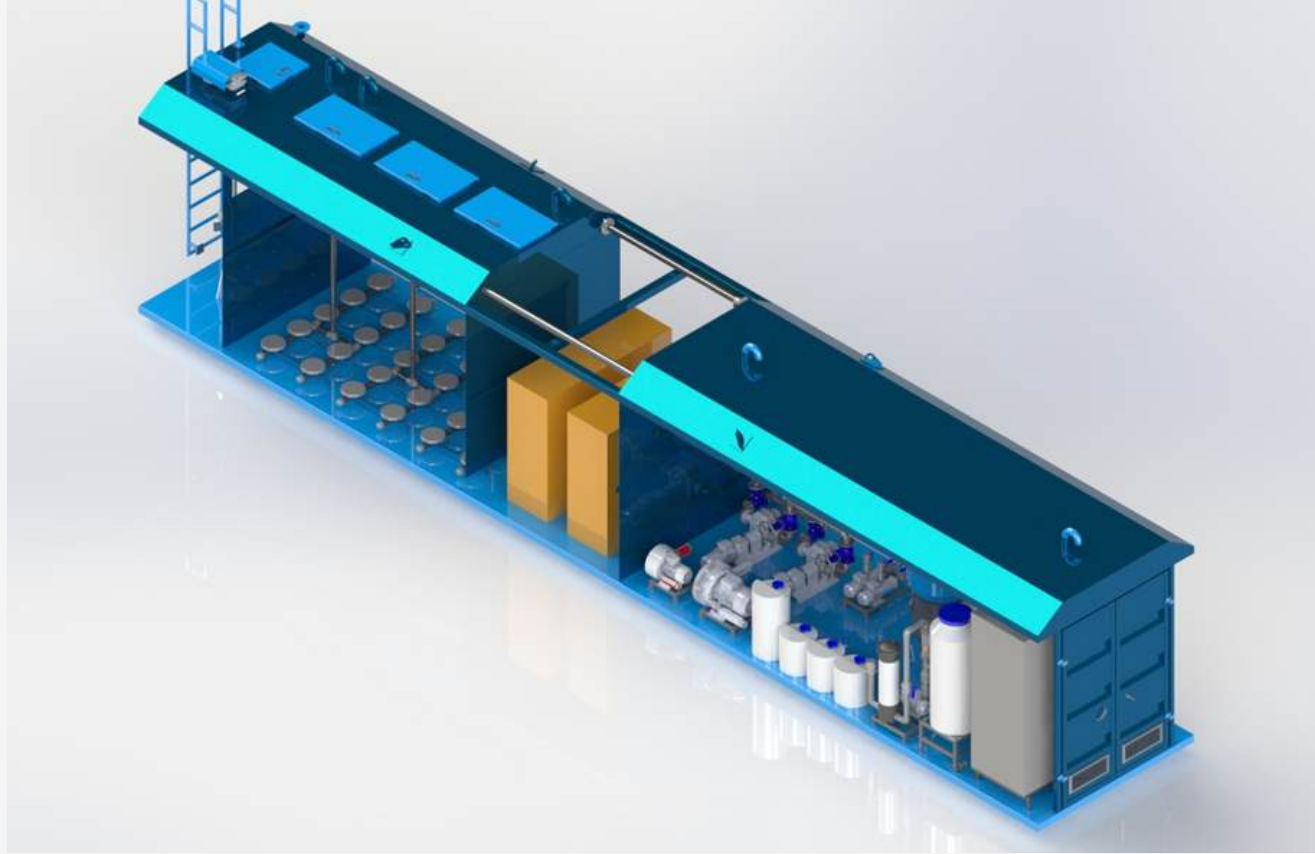

Azerbaijan

- It is a wastewater treatment method that combines the biological reactor with high efficiency technological membrane filtration, ensuring effective treatment of both domestic and industrial wastewater.
- Its primary advantage lies in its lower hydraulic retention time (HRT) requirement and the absence of the need for a final settling tank.
- This wastewater treatment method is preferred for its ability to provide efficient treatment in small areas.
- At the output of the MBR system, lower concentrations of COD, BOD, and TSS values are achieved.
- It is the preferred choice for wastewater with high levels of pollution.



PACKAGE TYPE TEXTILE WASTEWATER TREATMENT & RE-USE SYSTEMS



PACKAGE TYPE TEXTILE WASTEWATER TREATMENT & RE-USE SYSTEMS

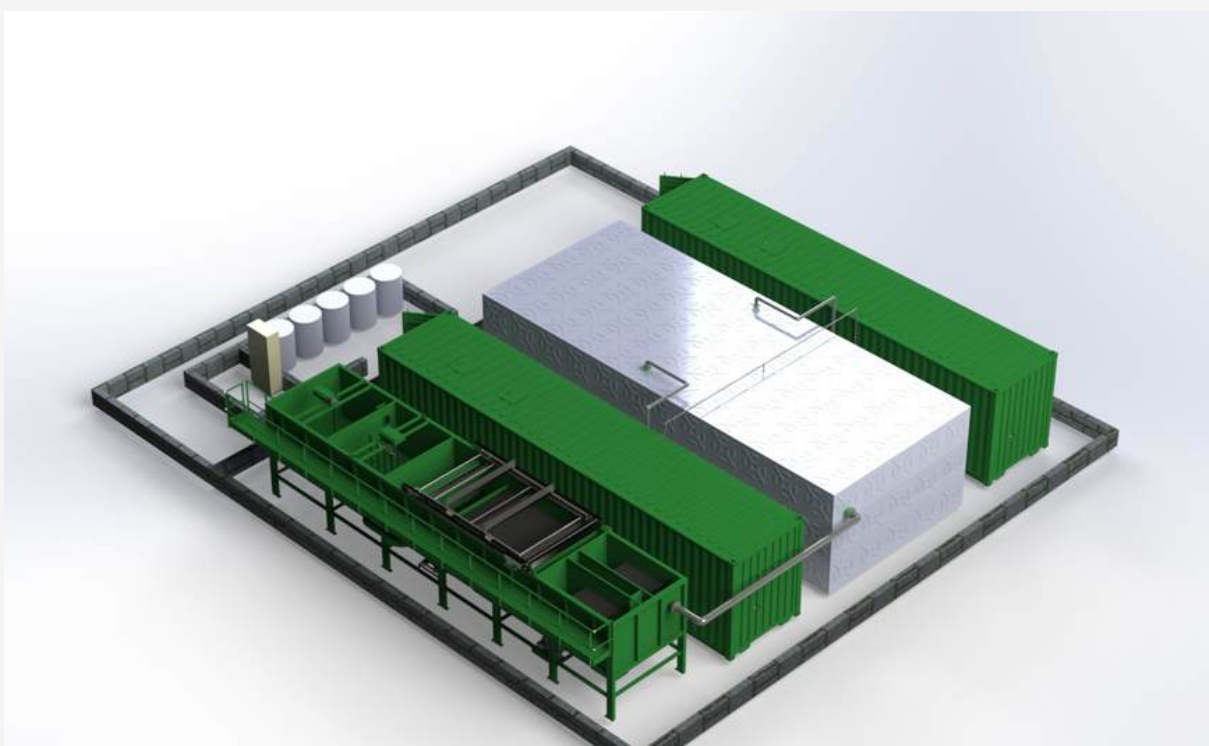
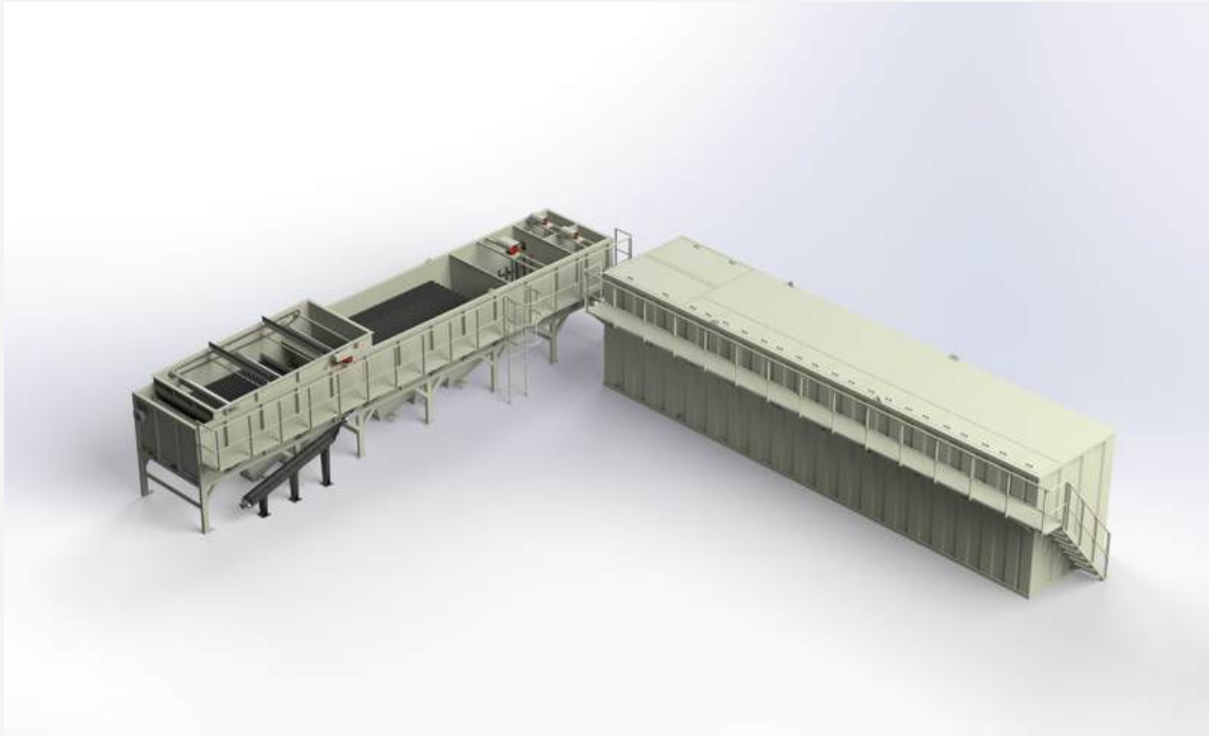

- The textile wastewater recovery system is capable of treating 90% or more of the wastewater generated by the textile washing and dyeing industry, thereby significantly enhancing the company's economic efficiency.
- This system can be implemented without requiring a dedicated building or additional space, offering added convenience.
- In the textile wastewater recovery system, all components are assembled and delivered within a container. Additionally, the system's capacity can be easily expanded by adding extra containers.

OUR REPRESENTATIVE OFFICES



RIPPALL LTD.

Swan Building, 20 Swan
Street,
Manchester/ENGLAND



VATEK-AL Sh.P.K

Rruga "Reshit Çollaku",
Pallati Nr. 38, Shkalla Nr. 1,
Apt.7, Kati 4
Tirane/ALBANIA



TRIWA FZCO

Dubai Silicon Oasis, DDP,
Building A1,
DUBAI /UNITED ARAB
EMIRATES



SAHRA ENGINEERING

Al-Shat Road, Souq Al-
Jumma District,
Tripoli / LIBYA



HEADQUARTER



Fatih Sultan Mehmet Mah. Poligon Cad.
Buyaka 2 Sitesi 3 Blok No:8C İç Kapı No:1
Ümraniye/İstanbul/ TÜRKİYE



+90 216 526 04 26



info@vatekcevre.com



FACTORY

Köseler Mah.31.Cad.Kobi OSB No:14
Dilovası / Kocaeli - Türkiye

